

PRODUCT & APPLICATION GUIDE

perma STAR VARIO & STAR CONTROL





Benefits of Automatic Lubrication

Page 4

- Bearing life extension
- Contamination prevention
- Safer Lubrication



Product Overview

Page 10

- perma STAR VARIO
- perma STAR VARIO BLUETOOTH®
- perma STAR CONTROL
- Lubricator Dispensing Rates
- Lubricator Operational Status



perma STAR VARIO Installation Kits

Page 20

- Introduction
- Standard Duty kits 60, 120 and 250cm³
- Heavy Duty kits 60, 120 and 250cm³
- Manifold kits
- Direct Mount and Rail Mount kits
- Standard Duty kits 500cm³
- Heavy Duty kits 500cm³



Remote Installation Guidelines

Page 34

Common Equipment & Applications

Page 36

- Slurry pumps
- Conveyor pulley bearings
- Electric motors
- Fans



General Accessories

Page 44

Fittings Cases

Page 48



Inspection Guidelines

Page 50

Service Guidelines

Page 51



Lubricants

Page 52

Notes

Page 54



The Expert in Lubrication Solutions

perma-tec GmbH & Co KG (Germany)

Inventing and patenting the perma CLASSIC single point lubricator in 1964, perma-tec GmbH & Co KG is the global leader in the research, development and manufacturing of automatic lubricators. perma lubrication systems can be found in all types of industries and applications around the world. perma lubrication systems are manufactured in Germany in state-of-the-art facilities.

HTL perma Australia Pty Ltd

As a subsidiary of perma-tec GmbH & Co, HTL perma Australia Pty Ltd has direct access to the Research & Development Centre and Engineering Group in Germany.

HTL perma Australia Pty Ltd responds to the demands of preventative maintenance programs by focusing on service, customised solutions and knowledge sharing. We understand that our products deliver maximum value when combined with robust installation systems, a practical approach to maintenance scheduling and ongoing technical support.

The information provided in this document is of a general nature only. Potential users of perma Automatic Lubricators should seek advice tailored to their particular circumstances and, for this purpose, are welcome to contact HTL perma Australia Pty Ltd on the contact number provided. HTL perma Australia Pty Ltd is not liable for any costs, losses or damages, whether direct or indirect, arising from any reliance upon this document. Details relating to product designs and specifications may be subject change without prior notice.

Benefits of Automatic Lubrication

Bearing life extension



Lubrication systems which deliver small volumes of lubricant at short time intervals extend bearing service life and deliver a reliability advantage.

The example below provides a statistical demonstration of a single point lubricator program at work.

A site with 500 perma single-point lubricators*, with an average setting of 3 months, reveals the following statistics.

- 2,000 injections of grease per year to each point
- An injection of grease, somewhere on site, every 32 seconds
- 2,740 individual injections per day
- 1 million individual injections per year

* For this example - perma STAR VARIO L250cc



To be competitive, manufacturing, mineral processing and mining operations must maximise production output while minimising long term operating costs and ensuring the safety of their personnel. A key component to achieving this is the implementation of preventative maintenance strategies which extend equipment service life and minimise the downtime required for maintenance, repair and overhaul. Success in this area reduces the total cost of ownership of production assets and ultimately improves business performance.

Cost and downtime due to premature wear is significant. For grease lubricated bearings, well considered lubrication strategies have a dramatic affect on extending bearing service life and therefore reducing costs and improving equipment reliability. The chart opposite provides estimates of the causes of premature bearing failures. Poor lubrication practices and contamination are the major causes.

In recognition of this, industry leading businesses invest in automatic lubrication systems for the purpose of bearing relubrication and contamination prevention because they deliver superior reliability results compared to manual lubrication.

Source: Statistical data for causes of failure varies depending on the source. It is generally accepted that more than half of premature bearing failures are lubrication or contamination related.
This data is from the Noria Corporation's "Machinery Lubrication" magazine, 4/2012.

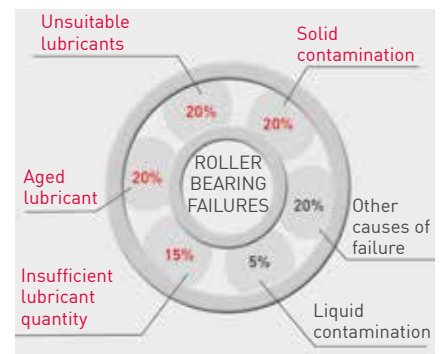

Benefits of short lubrication intervals



Bearing lubrication must fulfill the need to maintain sufficient fresh grease around the working components of bearings as they rotate. Insufficient or infrequent lubrication leads to the deterioration of lubrication conditions, lubricant starvation and premature wear. For high speed bearings, the rapid supply of large amounts of grease can cause over-lubrication which leads to degradation of grease condition and in severe cases may result in bearing failure.

The longest bearing service life is achieved when grease is added in small amounts at short time intervals. When implemented correctly, this regime of grease delivery maintains a steady-state of lubrication protection where over-lubrication and lubricant starvation do not occur.

Factors which reduce the service life of the grease include high speeds, high temperatures, vibration and high loads. When operating conditions such as these prevail, the benefits of delivering small amounts of grease at short time intervals are at their greatest.

The diagram opposite demonstrates the differences between lubrication methods which deliver small amounts of grease at short time intervals and those which deliver large amounts at extended time intervals.

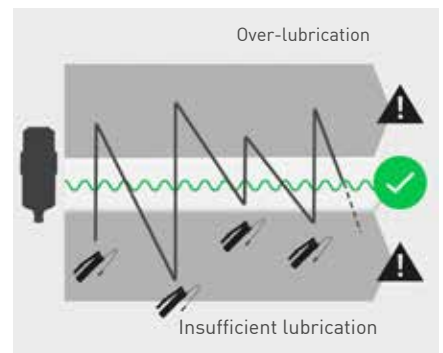

Too much grease

- Elevated operating temperature and rapid degradation of grease for high speed bearings
- Less efficient use of fresh grease
- Potential to damage contact type seals

Too little grease

- Starvation causing premature wear
- Accelerated degradation of grease
- Increased risk for contamination entry

Benefits of Automatic Lubrication

Contamination prevention



The contamination of bearings by water and solid particles causes accelerated wear and dramatically reduces bearing service life. Industries which involve the handling of abrasive material suffer the greatest losses as a result of inadequate contamination control procedures and systems.

perma automatic lubricators provide a means to achieve a purge of clean grease through bearing seals to prevent the entry of water, dirt and dust, and in doing so extend bearing service life.



When solid or liquid contaminants enter a bearing they cause accelerated wear and the early onset of fatigue. For solid contaminants the rate of wear increases with the size, concentration and hardness of contaminants. Smaller particles lead to abrasive wear whilst larger particles can cause indentation of bearing raceways which develop into sites of fatigue wear. Greasing practices which prevent the ingress of contaminants provide long term financial return by means of longer bearing service life and reduced downtime.

Strategies for preventing contamination vary depending on bearing housing and seal configurations. For bearings with free-purging labyrinth or taconite seals, contamination prevention is achieved by delivering a consistent purge of clean grease through the seals. In simple terms, if clean grease is purging out of the seal, contaminants, whether they be solid or liquid, are prevented from entering the bearing.

Bearings which operate in harsh environments, including high humidity and high levels of liquid or solid contaminants, demand the strictest attention to regular seal purging. Under such conditions automatic purging of seals provides the greatest benefits.

Strategies to prevent contaminant entry to bearings



Slurry pump seal purging

Automatic purging of labyrinth seals provides constant protection against ingress of solids and liquids. For pumps where the wet-end seal is subjected to water spray a higher rate of automatic purging is applied to compensate for the elevated rate of grease washout.



Conveyor pulley bearing relubrication & seal purging

Automatic purging of taconite or labyrinth type seals provides constant protection against the ingress of contaminants. For the example shown bearing relubrication is provided by a separate automatic lubricator.



Conveyor pulley bearing seal purging (hybrid solution)

Automatic purging of taconite or labyrinth type seals provides constant protection against the ingress of contaminants. Meanwhile, for the example shown, bearing relubrication is performed manually. This type of hybrid system can provide a practical balance between automatic and manual greasing for large pulley bearings.



Benefits of Automatic Lubrication

Workplace safety improvements



Workplace safety is of the highest importance. Reliable systems which reduce the interface between people and operating equipment are a key element to eliminating workplace accidents.

Automatic systems provide a valuable contribution to reducing the likelihood of workplace accidents by significantly reducing the time required to lubricate equipment.



Automatic lubrication systems are maintenance tools which make a positive contribution to work place safety and efficiency. This is particularly the case for large operations in hot climates where the physical demands of performing regular manual greasing increase the risk of fatigue and heat exhaustion compared to automatic alternatives.

The implementation of automatic lubrication systems does not mean that the frequency of equipment inspections should be reduced. Automatic systems save time which can be invested into other tasks such as mechanical inspections, condition monitoring data collection and oil cleanliness management activities such as filtration and clarification.

Strategies to improve safety and efficiency



Strategy 1 – Remote mount lubricators for large electric motors, fans and pumps at safe and easy to reach locations.

Safety – Improve safety via the remote installation of lubricators at safe to access locations.

Efficiency – Save time which would otherwise be required to locate and use safety steps.

Example - Direct mounting of lubricators to the fan bearings shown would require personnel to climb onto the fan structure or use a safety step for lubricator inspection and servicing. The remote mounting solution allows lubricators to be safely handled from ground level.



Strategy 2 – Automatically lubricate equipment which would otherwise require working at heights or confined space permits.

Safety – Improve safety by reducing the need to perform work at heights or within confined spaces.

Efficiency – Save time which would otherwise be required during shuts for permits, isolations, equipment preparation and other time consuming requirements.

Example - The perma STAR VARIO lubricator shown is lubricating the bearing of a gravity take-up pulley on a conveyor via a 5 meter long remote grease line.



Strategy 3 – Remote mount lubricators used for conveyor pulley bearings which are located behind cages and avoid unnecessary manual handling of cages.

Safety – Improve safety by avoiding the need to lift and handle cages and guards.

Efficiency – Save time which would otherwise be required during shuts for permits, isolations, cage removal and cage reinstatement.

Example - The perma STAR VARIO lubricators shown are delivering grease to the bearing relubrication point and seal purge point of a conveyor pulley bearing.



perma STAR VARIO

Electro-mechanical, weekly and monthly time settings and four cartridge sizes



perma STAR VARIO consists of a reusable electro-mechanical drive unit and a single-use lubricant cartridge. Because the lubricator is mechanically driven the dispensing rate is independent of ambient temperature and flow resistance*. Inspection of the perma STAR VARIO is made easy via the combination of the transparent lubricant cartridge, a flashing LED alert system and an LCD display screen which communicates the status of the lubricator to maintenance personnel.

*Total resistance to grease flow must be less than the pressure delivery capability of the lubricator.

Applications

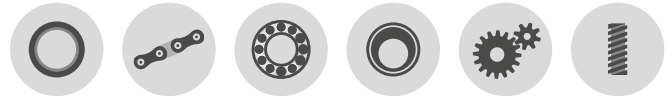

perma STAR VARIO is a single-point, automatic lubricator which is suited to a broad range of bearing and chain applications. perma STAR VARIO is ideal for applications which demand precise grease delivery or for operating environments which include significant temperature fluctuations. The remote installation kits for perma STAR VARIO provide practical solutions for lubricators to be installed at safe and easy to reach locations.



Product characteristics



LCD display with push button shows discharge period, LC size and operating status

Setting: Weekly or monthly and four cartridge sizes



Electromechanical, reusable drive unit

All around visible LED lights signal function and errors



Pressure build-up to 7.5 bar allows remote mounting with lines up to 5 meters*

Purge function

Benefits

- Simple to navigate menu with LCD display makes the system easy to set
- Broad range of setting options reduces compromise when selecting lubricant dispensing rates and provides greater flexibility for service planning
- System can be turned off for extended equipment shut downs
- Precise lubricant dispensing which is independent of temperature and flow resistance*
- Simple to inspect via the combination of the flashing LED system, LCD display and transparent lubricant cartridge.
- Extensive options for remote mounting lubricators at safe to access locations
- Remote mounting reduces the dependence on time during maintenance shutdowns for lubricator servicing and reduces the requirement to perform time consuming equipment isolations

Technical data

Power supply

STAR VARIO battery pack 4.5 V

Discharge period

1, 212 months for 60, 120 & 250cm³

1, 2 6 months for 500cm³

1, 226 weeks for all sizes

Lubricant volume

60cm³, 120cm³, 250cm³ or 500cm³

Operating temperatures

-20°C to +60°C

Protection class

IP 65

Standard & special lubricants

Oil / Grease up to NLGI2

Remote installations

5 meters of 3/8" ID line (grease)

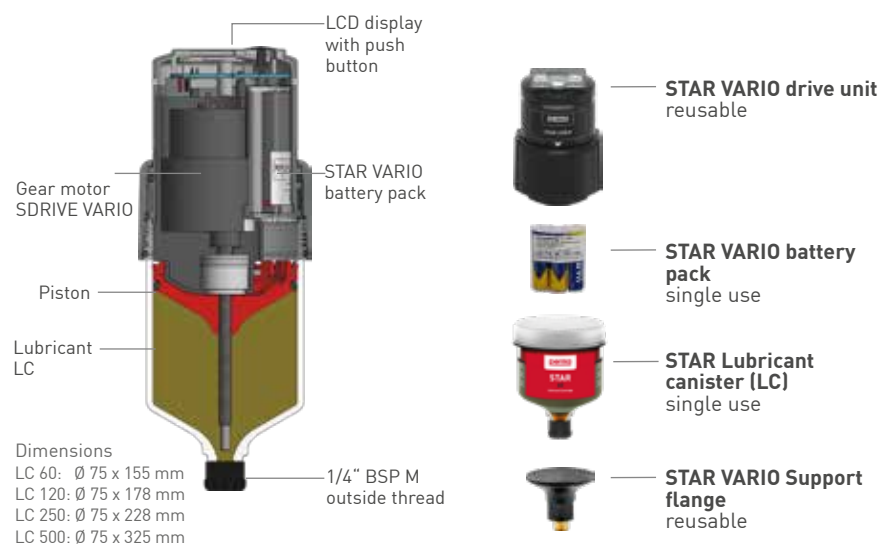

* Total resistance to grease flow must be less than the pressure delivery capability of the lubricator

perma STAR VARIO BLUETOOTH®

Electro-mechanical, weekly and monthly time setting options, four cartridge sizes and Bluetooth®



perma STAR VARIO BLUETOOTH® combines all of the performance features of the perma STAR VARIO and the new features of Bluetooth® connectivity and a backlit display. The remote installation options provide opportunities to improve workplace safety by installing the systems at a safe and easy to access locations. Use of the system is simple and intuitive with programming via the set button or the perma CONNECT APP.

The operational status of the system is communicated in a variety of convenient ways. Users of the system can view the status via the Bluetooth® feature using the perma CONNECT APP. Alternatively, without using the App, the combination of the back-lit display and the bright red and green signal lights provide immediate confirmation of the system status.

Applications

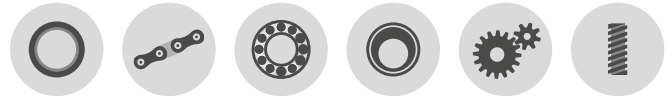

perma STAR VARIO BLUETOOTH® is a single-point, automatic lubricator which is suited to a broad range of bearing and chain applications where wireless connection for system status confirmation and control is required. perma STAR VARIO BLUETOOTH® is ideal for equipment which is difficult or time consuming to access for the purpose of lubricator inspection.



Product characteristics



LCD display with push button shows discharge period, LC size and operating status

Setting: Weekly or monthly and four cartridge sizes

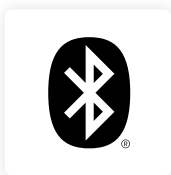

Bluetooth® function

Simple operation via the perma CONNECT APP

Backlit display



Pressure build-up to 7.5 bar allows remote mounting with lines up to 5 meters*

Purge function

Benefits

- Simple to navigate menu with LCD display makes the system easy to set
- Broad range of setting options reduces compromise when selecting lubricant dispensing rates and provides greater flexibility for service planning
- System can be turned off for extended equipment shut downs
- Bluetooth® function
- Remote configuration, control operational status confirmation
- Increased workplace safety
- Function monitoring in real time
- Extensive options for remote mounting lubricators at safe to access locations
- Remote mounting reduces the dependence on time during maintenance shutdowns for lubricator servicing and reduces the requirement to perform time consuming equipment isolations

Technical data

Power supply

STAR VARIO battery pack 4.5 V

Discharge period

1, 2 12 months for 60, 120 & 250cm³

1, 2 6 months for 500cm³

1, 2 26 weeks for all sizes

Lubricant volume

60cm³, 120cm³, 250cm³ or 500cm³

Operating temperatures

-20°C to +60°C

Protection class

IP 65

Standard & special lubricants

Oil / Grease up to NLGI2

Remote installations

5 meters of 3/8" ID line (grease)

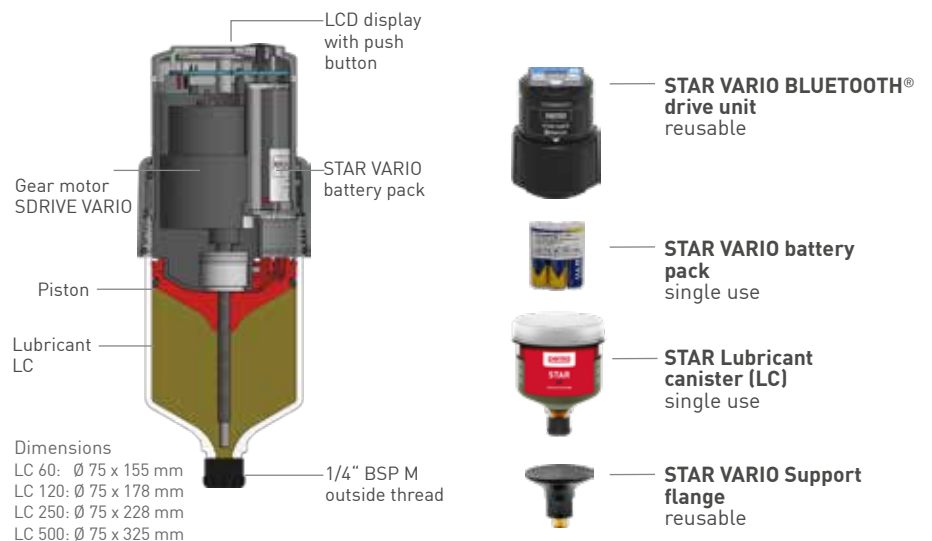

* Total resistance to grease flow must be less than the pressure delivery capability of the lubricator

perma STAR CONTROL

PLC / machine controlled lubricant delivery



Similar to the perma STAR VARIO, the perma STAR CONTROL delivers precise amounts of lubricant and its operation is temperature independent. The unique feature of the perma STAR CONTROL is its connection to machine control. This feature makes the perma STAR CONTROL ideally suited to equipment where re-lubrication is to take place only when the machine is in operation, for critical equipment which has low utilisation or for standby equipment.

The perma STAR CONTROL consists of an electromechanical drive and a lubricant canister with 60 , 120, 250 or 500cm³ of lubricant. The perma STAR CONTROL has two operating modes: TIME and IMPULSE.

Applications

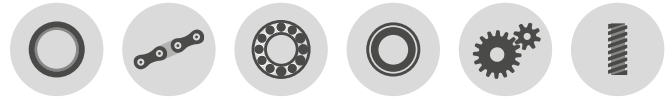

perma STAR CONTROL is a PLC controlled single-point, automatic lubricator which is suited to a range of bearing and chain applications. There are two modes of operation which are available via the SET button controlled menu – TIME and IMPULSE. For IMPULSE version mode the lubricator discharges a set volume of lubricant as soon as voltage is applied. Before it will discharge again, voltage must be interrupted for at least 5 seconds and then reapplied. Meanwhile TIME mode dispenses lubricant at a set rate of cm^3 per 100 hours of machine operation, stopping and starting at preset intervals.



Product characteristics



LCD display with push button shows discharge period, LC size and operating status
Machine controlled:
LED indicator lights (green and red) and operating status



Electromechanical, reusable drive unit.
LCD display and single set button menu interface



Pressure build-up to 6 bar allows remote mounting with lines up to 5 meters*
Purge function

Benefits

- Cable connection allows control of lubricant dispensing and the capability to provide operational status details of the lubrication system via PLC interface
- LED lights provide indication of lubrication system operational status in areas of poor light
- Simple handling and programming via intuitive menu
- Broad range of setting options for both TIME and IMPULSE modes
- LCD display provides immediate confirmation of lubrication system operational status
- Extensive options for remote mounting lubricators at safe to access locations
- Remote mounting reduces the dependence on time during maintenance shutdowns for lubricator servicing and reduces the requirement to perform time consuming equipment isolations

Technical data

Power supply
Electromechanical function
external voltage: 9-30 V DC, I_{max} 0.5 A

Discharge period
Timed (TIME mode)
Pulse (IMPULSE mode)

Lubricant volume
60 cm^3 , 120 cm^3 , 250 cm^3 or 500 cm^3

Operating temperatures
-10°C to +60°C

Protection class
IP 65

Standard & special lubricants
Oil / Grease up to NLGI2

Remote installations
5 meters of 3/8" ID line (grease)

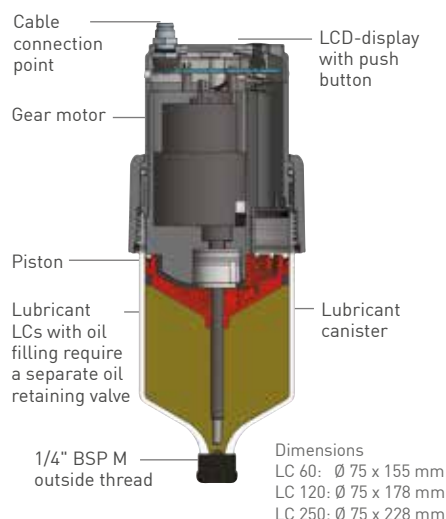

Dispensing rates

Weekly settings

The dispensing rate data tabled below applies to the perma STAR VARIO and STAR VARIO Bluetooth®. Details on the dwell time between lubricant delivery cycles are available upon request.

Time setting, weeks	Daily dispensing rate, cm ³ per day			
	60cm ³	120cm ³	250cm ³	500cm ³
1	8.57	17.14	35.71	71.43
2	4.29	8.57	17.86	35.71
3	2.86	5.71	11.90	23.81
4	2.14	4.29	8.93	17.86
5	1.71	3.43	7.14	14.29
6	1.43	2.86	5.95	11.90
7	1.22	2.45	5.10	10.20
8	1.07	2.14	4.46	8.93
9	0.95	1.90	3.97	7.94
10	0.86	1.71	3.57	7.14
11	0.78	1.56	3.25	6.49
12	0.71	1.43	2.98	5.95
13	0.66	1.32	2.75	5.49
14	0.61	1.22	2.55	5.10
15	0.57	1.14	2.38	4.76
16	0.54	1.07	2.23	4.46
17	0.50	1.01	2.10	4.20
18	0.48	0.95	1.98	3.97
19	0.45	0.90	1.88	3.76
20	0.43	0.86	1.79	3.57
21	0.41	0.82	1.70	3.40
22	0.39	0.78	1.62	3.25
23	0.37	0.75	1.55	3.11
24	0.36	0.71	1.49	2.98
25	0.34	0.69	1.43	2.86
26	0.33	0.66	1.37	2.75

Dispensing rates

Monthly settings

The dispensing rate data tabled below applies to the perma STAR VARIO and STAR VARIO Bluetooth®. Details on the dwell time between lubricant delivery cycles are available upon request.

Time setting, months	Daily dispensing rate, cm ³ per day			
	60cm ³	120cm ³	250cm ³	500cm ³
1	1.97	3.95	8.22	16.45
2	0.99	1.97	4.11	8.22
3	0.66	1.32	2.74	5.48
4	0.49	0.99	2.06	4.11
5	0.39	0.79	1.64	3.29
6	0.33	0.66	1.37	2.74
7	0.28	0.56	1.17	-
8	0.25	0.49	1.03	-
9	0.22	0.44	0.91	-
10	0.20	0.39	0.82	-
11	0.18	0.36	0.75	-
12	0.16	0.33	0.69	-











LUBRICATING THE WHEELS OF RESEARCH FOR THE NATIONAL BREAST CANCER FOUNDATION

NBCF perma FLEX is made in Germany and supports our corporate partnership with the National Breast Cancer Foundation. The NBCF perma FLEX is ideal when a compact, lightweight, automatic lubricator is required for direction mounting to lubrication points.



Lubricator operational status

Display and light sequences

Lights & Display Screen	Lubricator Status	Action	
	DISPLAY Shows the time setting and a flashing line above the lubricant canister size. LIGHTS Green 7 seconds	DWELL Lubricator is between dispensing cycles, waiting to commence the next programmed lubricant delivery cycle.	Inspect integrity of lubricator, grease line and fittings. Mark and date the position of the piston to identify that an inspection has been completed.
	DISPLAY  = run LIGHTS Green 1 seconds	DISPENSING Lubricator is dispensing lubricant.	Wait for run cycle to finish and inspect.
	DISPLAY  = purge LIGHTS Green 1 seconds	PURGE Lubricator purge mode has been activated and lubricant is being dispensed.	PURGE is activated by holding down the SET button for 10 seconds to deliver 6 cm ³ . The purge cycle can be interrupted at any time by pressing the SET button.
	DISPLAY  = lubricant canister LIGHTS Red 2 seconds	CANISTER EMPTY Based on the programmed setting the canister should be empty.	Service the lubricator using a new canister and a new battery set. To reset the lubricator for the next canister a new battery set must be inserted.
	DISPLAY  = overload LIGHTS Red 7 seconds	OVERLOAD The lubricator has experienced high resistance from the lubrication point and has been unable to deliver the lubricant.	Manually purge the point to clear the blockage. The lubricator can be restarted by turning it on and off again. If the overload persists the cause of the blockage must be addressed.
	DISPLAY  = low battery LIGHTS Red 2 seconds	LOW BATTERY The inserted battery set is either already depleted or damaged.	Replace with a new battery set.

Days since empty count



It is recommended to always write the installation date on the cartridge of perma STAR VARIO lubricators. This provides valuable information to personnel involved in lubricator inspections. In particular, if a lubricator is found to be empty, the recorded date allows the period for which lubricant has not been delivered to be determined, which in turn allows the equipment maintainer to determine the appropriate maintenance action.

For occasions where an installation date has not been recorded the perma STAR VARIO* provides a count of the number of days for which the cartridge has been empty. Refer below for details.

*This feature is only available for perma STAR VARIO drive units with software version 3.4 onwards. Contact your supplier of perma products for more information.

Information from empty lubricators



As shown in the table opposite, when the lubricant cartridge is empty the lubricator display screen shows LC and the LEDs flash red every 2 seconds.

When LC is displayed the time setting and count of the number of days that the cartridge has been empty can be obtained. This information assists equipment maintainers to make decisions about the most appropriate action when lubricators are found to be empty, especially when lubricant cartridges have not been clearly marked with the installation date.

To confirm the lubricator time setting press and hold the SET button for 1 second, then release the SET button to confirm the number of days since empty. The display will automatically alternate between "rd" and the day count, up to a maximum of 99 days. After alternating between "rd" and the day count eight times the display will return to "LC". rd = days count since red.

Example - A 250cc lubricator is found to be empty, displaying LC, with no date markings on the lubricant cartridge. By holding the SET button down for 1 second it is confirmed that the time setting is 6 months and that the lubricator has been empty for 2 days. The display sequence is shown below.

This information would indicate to the equipment maintainer that no special action is required other than the normal lubricator servicing procedure.

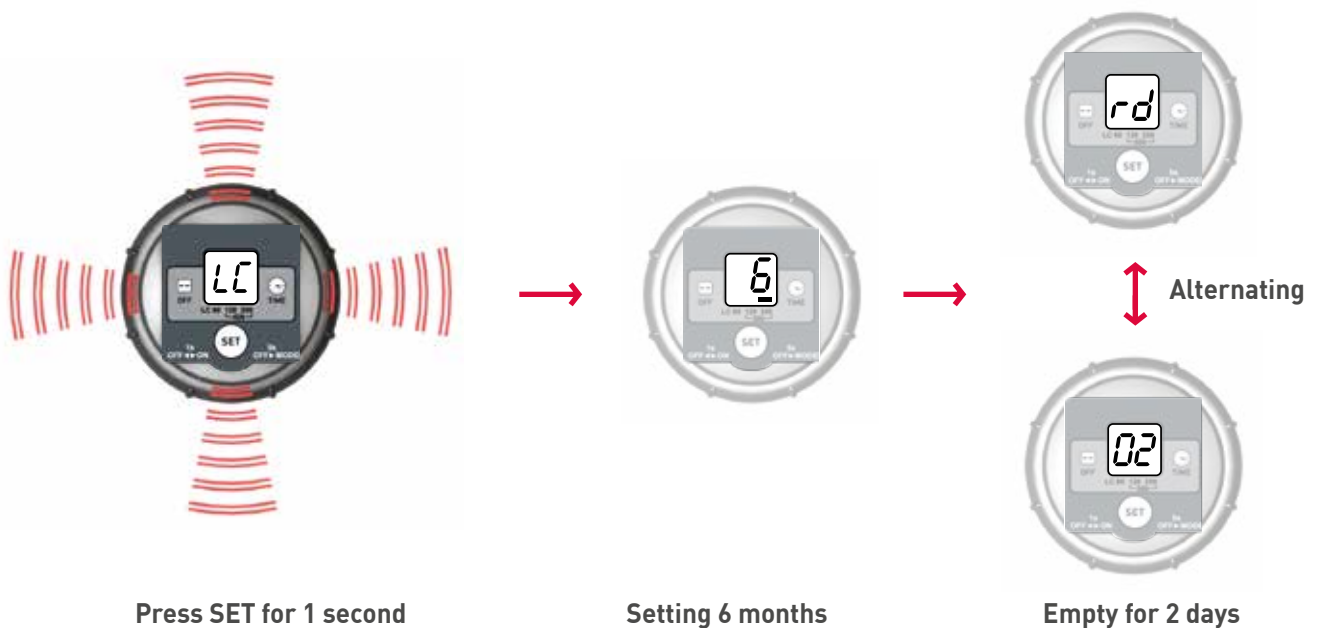

Installation Kits*

Introduction

A. Full length protection covers

Covers to protect lubricators from solid and liquid contaminants.

B. Manual purge point

Used for convenient additions of supplementary grease, line purging and grease blockage clearing.

C. Elbows

Elbow fittings are full bore with 1/4" BSP threads.

D. Stainless steel bracket

There are two main categories of brackets – Standard Duty and Heavy Duty. The example shown here is the Heavy Duty C-section design which provides complete protection to lubricators.

E. Stainless steel beam clamps

Simple to use beam clamps supplied with case hardened cup head set screws and stainless steel assembly screws.

F. Support flanges & cover clips

Support flanges provide robust support against damage due to impacts or vibration. Cover clips improve contamination control and retain full length covers.

G. Heavy duty hose

Quality Ryco brand hose. Supplied with 3/8" internal diameter and easy to use push-lock type swivel hose ends.



Remote installation kits are designed to be installed with maximum efficiency. Kit brackets and covers have been designed to provide suitable protection to the lubricator against accidental damage and contamination build-up. Grease line type and fittings have been carefully selected to minimise resistance to grease flow.

* All perma STAR VARIO installation kits are compatible with perma STAR VARIO BLUETOOTH® and perma STAR CONTROL lubricators.

Introduction

A comprehensive range of remote installation kits is available for the perma STAR VARIO and STAR CONTROL. Available in 1, 2, 3 and 4 point configurations, the kits are designed to be simple to install and to provide long term durability. The brackets are fabricated from stainless steel and are secured to beam sections, cage mesh or round rails using simple attachment methods. Installations can be completed quickly, without the need for power tools or hot work.

What is included in installation kits for perma STAR VARIO?

The list below summarise the components included in perma STAR VARIO and STAR CONTROL remote installation kits. The image opposite provides an example of the components – the example shown has the part number K265C.

- Stainless steel bracket
- Attachment option (beam clamps, cage hooks or U-bolts)
- Manual purge points (one per point)
- Lubricator support flanges (one per point)
- Full length covers (one per point)
- Grease line (2 meters per point)
- Push lock, swivel hose ends with adaptor to 1/4" BSP male (2 per point)
- Spiral wrap (0.5 meter per kit)
- Adaptors 1/4" BSP female to 1/4" BSP male (one per point)
- Reducers 1/4" BSP female to 1/8" BSP male (one per point)
- Elbows 90°C full bore 1/4" BSP (one per point)

Bracket types - Standard Duty & Heavy Duty

There are two main categories of brackets: Standard Duty and Heavy Duty. Both categories include stainless steel construction, 1/4" BSP female sockets and laser cut profiles to minimise contamination build-up. Heavy Duty brackets also feature a C-section design which provides a more secure design for retaining the lubricator covers.

The C-section design is especially suited to installations which are to be subjected to water wash down, as would be anticipated for applications such as slurry pumps in coal preparation plants. This design also provides greater mounting flexibility due to the 4-slot design of the bracket mounting face.



Custom designs

Installation kits can be customised to meet customer specific requirements. Customisation can include manifold brackets, customised brackets to suit specific equipment or mounting needs, pre-assembled & pre-filled grease lines and application specific fittings.

Manifold design example

For applications where higher grease rates are required or when the rationalisation of lubricator time settings is important.

Example: K230J



Installation Kits*

Standard Duty - 60, 120 and 250cm³



Standard Duty installation kits are highly versatile and can be adapted for attachment to beam sections or square mesh safety cages. The brackets included in Standard Duty kits are fabricated in Australia from stainless steel.

Standard Duty kits include lubricator covers and manual purge kits for each lubrication point along with a range of commonly required fittings, push-lock swivel hose ends and high quality Ryco brand hose with 3/8" internal diameter.

* All perma STAR VARIO installation kits are compatible with perma STAR VARIO BLUETOOTH® and perma STAR CONTROL lubricators.

Standard Duty Beam

The range of Standard Duty kits with beam clamps includes options for 1, 2, 3 or 4 points. Beam clamp options include 30mm and 65mm sizes, as indicated by the 3rd and 4th digits of the product part number – **30** for 30mm clamps and **65** for 65mm clamps.



K130 (with 30mm beam clamps)
K165 (with 65mm beam clamps)



K230 (with 30mm beam clamps)
K265 (with 65mm beam clamps)



K330 (with 30mm beam clamps)
K365 (with 65mm beam clamps)



K430 (with 30mm beam clamps)
K465 (with 65mm beam clamps)

Example installation kit contents – K230

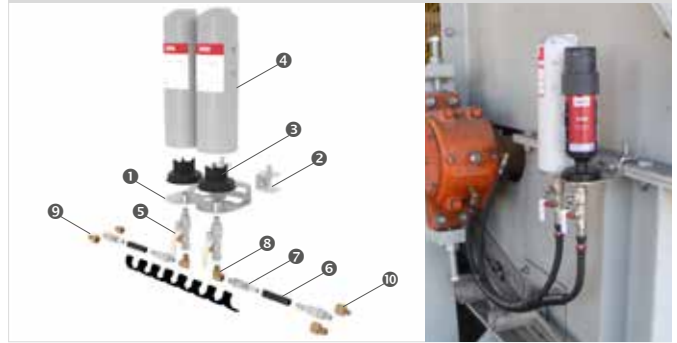

Bill of Materials

1	1 x 2 point standard duty bracket	6	4m of 3/8" ID grease line
2	2 x 30mm S/S beam clamps	7	4 x female swivel hose ends
3	2 x lubricator support flanges	8	2 x 90 degree elbows
4	2 x full length covers	9	2 x 1/4" BSPF-1/8" BSPM reducers
5	2 x manual purge kits	10	2 x 1/4" BSPF -1/4" BSPM extension

Standard Duty Cage Mount

The range of Standard Duty installation kits with cage hooks are suited to square cage down to a mesh size of 25 x 25mm. Installation kits are available for 1, 2, 3 or 4 points as summarised below. **CH** as the 3rd and 4th digits of the product part number indicates the inclusion of cage hook.



K1CH



K2CH



K3CH



K4CH

Example installation kit contents – K2CH



Bill of Materials

1	1 x 2 point standard duty cage bracket	6	4 x Female swivel hose ends
2	2 x Lubricator support flanges	7	2 x 90 degree elbows
3	2 x full length covers	8	2 x 1/4" BSPF-1/8" BSPM reducers
4	2 x Manual purge kits	9	2 x 1/4" BSPF -1/4" BSPM extension
5	4m of 3/8" ID grease line		

Installation Kits*

Heavy Duty - 60, 120 and 250cm³



Heavy Duty installation kits have been specifically designed for use in operational areas which are subject to regular wash down and water impact, such as the conditions found in coal handling preparation plants. The installation kits are highly versatile and can be adapted for attachment to beam sections and square mesh safety cages. The bracket systems included in Heavy Duty installation kits are fabricated in Australia from stainless steel.

Heavy Duty installation kits include lubricator covers and manual purge kits for each lubrication point along with a range of commonly required fittings, push-lock swivel hose ends and high quality Ryco brand hose with 3/8" internal diameter.

* All perma STAR VARIO installation kits are compatible with perma STAR VARIO BLUETOOTH® and perma STAR CONTROL lubricators.

Heavy Duty Beam

The range of Heavy Duty kits with beam clamps includes options for 1, 2, 3 or 4 points. Beam clamp options include 30mm and 65mm sizes, as indicated by the 3rd and 4th digits of the product part number – **30** for 30mm clamps and **65** for 65mm clamps.



K130C (with 30mm beam clamps)
K165C (with 65mm beam clamps)



K230C (with 30mm beam clamps)
K265C (with 65mm beam clamps)



K330C (with 30mm beam clamps)
K365C (with 65mm beam clamps)



K430C (with 30mm beam clamps)
K465C (with 65mm beam clamps)

Example Installation Kit Contents – K230C

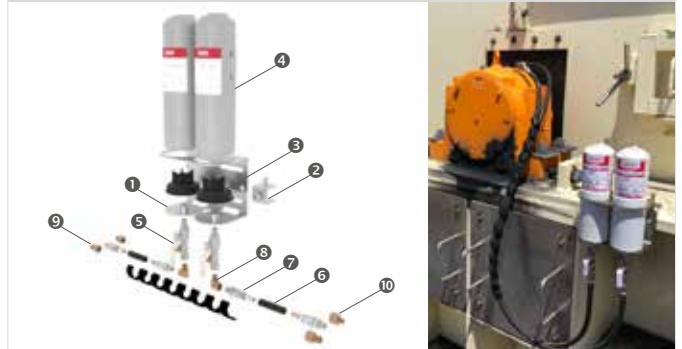

Bill of Materials

1	1 x 2 point heavy duty bracket	6	4m of 3/8" ID grease line
2	2 x 30mm S/S beam clamps	7	4 x female swivel hose ends
3	2 x lubricator support flanges	8	2 x 90 degree elbows
4	2 x full length covers	9	2 x 1/4" BSPF-1/8" BSPM reducers
5	2 x manual purge kits	10	2 x 1/4" BSPF -1/4" BSPM extension

Heavy Duty Cage Mount

The range of Heavy Duty installation kits with cage hooks are suited to square cage down to a mesh size of 25 x 25mm. Installation kits are available for 1, 2, 3 or 4 points as summarised below. **CH** as the 3rd and 4th digits of the product part number indicates the inclusion of cage hook.



K1CHC



K2CHC



K3CHC



K4CHC

Example Installation Kit Contents – K2CHC

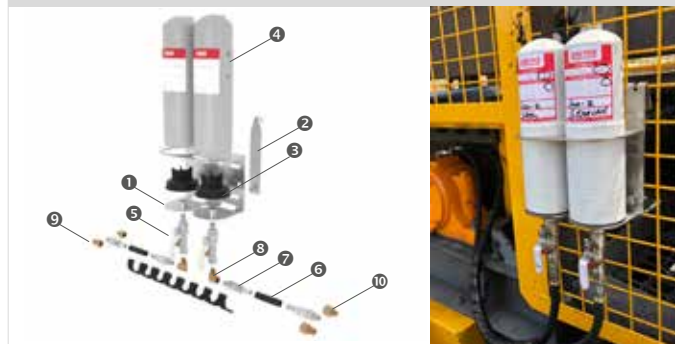

Bill of Materials

1	1 x 2 point heavy duty bracket	6	4m of 3/8" ID grease line
2	1 x cage hook arm set	7	4 x female swivel hose ends
3	2 x lubricator support flanges	8	2 x 90 degree elbows
4	2 x full length covers	9	2 x 1/4" BSPF-1/8" BSPM reducers
5	2 x manual purge kits	10	2 x 1/4" BSPF -1/4" BSPM extension

Installation Kits*

Manifold



Installation kits which incorporate two and three point manifolds are available with combinations of standard duty and heavy duty bracket designs, plus the option of beam or cage mount. Manifold installation kits should be considered for use where an elevated grease dispensing rate is required or where a particular service period is to be targeted.

For example, if a lubrication point requires a grease application rate equivalent to a 1 month setting, but the target minimum service period for the equipment is 2 months, a 2-point manifold arrangement can be utilised with a two month time setting.

* All perma STAR VARIO installation kits are compatible with perma STAR VARIO BLUETOOTH® and perma STAR CONTROL lubricators.

Manifold Beam

Beam clamp options include 30mm and 65mm sizes, as indicated by the 3rd and 4th digits of the product part number – 30 for 30mm clamps and 65 for 65mm clamps. The inclusion of a C in the part number indicates a heavy duty C-section brackets and the inclusion of a J indicates that the bracket is a manifold design (J = joined).



K230J (with 30mm beam clamps)
K265J (with 65mm beam clamps)



K330J (with 30mm beam clamps)
K365J (with 65mm beam clamps)

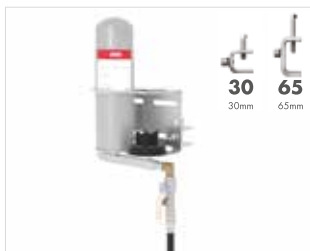

K230CJ (with 30mm beam clamps)
K265CJ (with 65mm beam clamps)



K330CJ (with 30mm beam clamps)
K365CJ (with 65mm beam clamps)

Example Installation Kit Contents – K230J

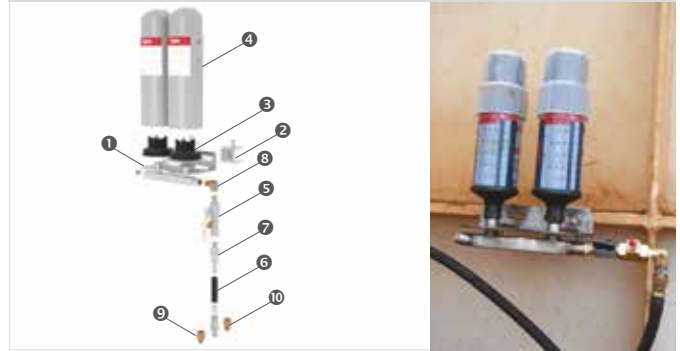

Bill of Materials

1	1 x 2 point manifold bracket	6	4m of 3/8" ID grease line
2	2 x 30mm S/S beam clamps	7	4 x female swivel hose ends
3	2 x lubricator support flanges	8	2 x 90 degree elbows
4	2 x full length covers	9	2 x 1/4" BSPF-1/8" BSPM reducers
5	2 x manual purge kits	10	2 x 1/4" BSPF -1/4" BSPM ext.

Manifold Cage Mount

Cage mount options are suited to square cage mesh down to a size of 25mm x 25mm. The inclusion of a C in the part number indicates a heavy duty C-section brackets and the inclusion of a J indicates that the bracket is a manifold design (J = joined)



K2CHJ



K3CHJ



K2CHCJ



K3CHCJ

Example Installation Kit Contents – K2CHCJ

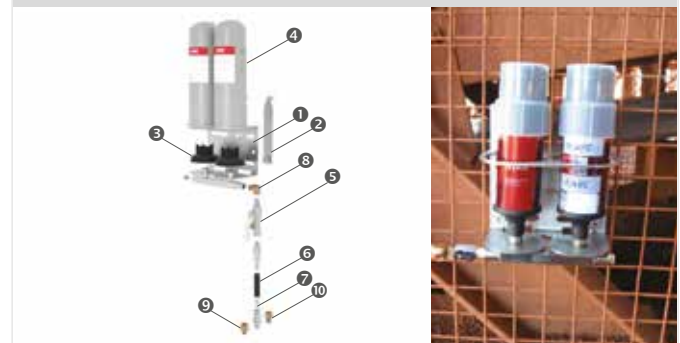

Bill of Materials

1	1 x 2 point manifold bracket	6	4m of 3/8" ID grease line
2	1 x cage hook arm set	7	4 x female swivel hose ends
3	2 x lubricator support flanges	8	2 x 90 degree elbows
4	2 x full length covers	9	2 x 1/4" BSPF-1/8" BSPM reducers
5	2 x manual purge kits	10	2 x 1/4" BSPF -1/4" BSPM ext.

Installation Kits*

Direct and rail



Direct mount

Where there is safe access to the lubrication point while plant is operating, direct mounting should be considered. Direct mounting presents maximum grease pressure to the lubrication point and is the lowest cost form of installation. Direct mounting should not be implemented where doing so presents a safety compromise or where the risk of damage to the lubrication system is increased due to the likelihood of accidental knocks or impact from process material.

Rail mount

Rail mount installation kits utilise u-bolts for attachment to round rails with the size range of 30 to 50mm diameter. Rail mount installation kits should only be used on intermediate rails and must not be installed at locations where the bracket will interfere with access and function of hand rails.

* All perma STAR VARIO installation kits are compatible with perma STAR VARIO BLUETOOTH® and perma STAR CONTROL lubricators.

Rail

The range of rail mount kits includes options for 1, 2, 3 or 4 points. Rail mount brackets are secured using u-bolts which are suited to round rails with outer diameters between 30 and 50mm. The rail mount design is indicated by RR as the 3rd and 4th digits of the product part number.



K1RR



K2RR

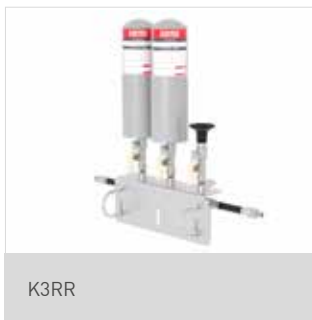

K3RR

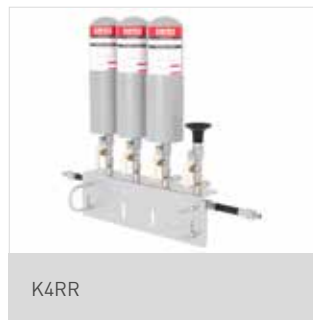

K4RR

Example Installation Kit Contents – K1RR

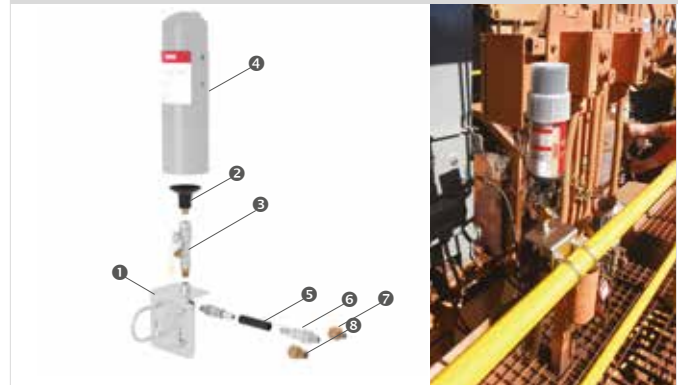

Bill of Materials

1	1 x 1 point rail bracket	5	2m of 3/8" ID grease line
2	1 x lubricator support flanges	6	2 x female swivel hose ends
3	1 x manual purge kits	7	1 x 1/4" BSPF-1/8" BSPM reducers
4	1 x full length cover	8	1 x 1/4" BSPF -1/4" BSPM extension

Direct Mount Installation Kits

Direct mount kits are for single point installations and include a full length cover, cover clip, stainless steel support disc with 1/4" BSP socket, a manual purge kit and various adaptors. The combination of the cover, cover clip and stainless steel disc provides protection from contamination build-up on the lubricator.

Customised direct mount installation kits, including different reducer and elbow fitting combinations, are available upon request.



KD250-708V



KD250-708V45

Kit Contents – KD250-708V



Bill of Materials

1	1 x full length cover
2	1 x support flange 1/4" BSP
3	1 x stainless steel disc & cover clip
4	1 x manual purge kit
5	1 x stainless steel reducer 1/4" BSPF to 1/8" BSPM

Kit Contents – KD250-708V45

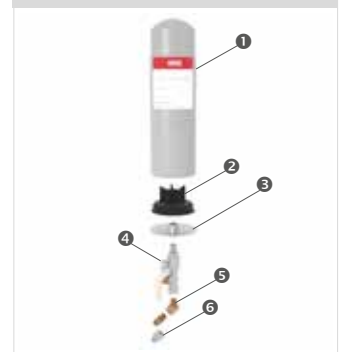

Bill of Materials

1	1 x full length cover
2	1 x support flange 1/4" BSP
3	1 x stainless steel disc & cover clip
4	1 x manual purge kit
5	1 x elbow 45° 1/4" BSP
6	1 x stainless steel reducer 1/4" BSPF to 1/8" BSPM

Installation Kits*

Standard Duty - 500cm³

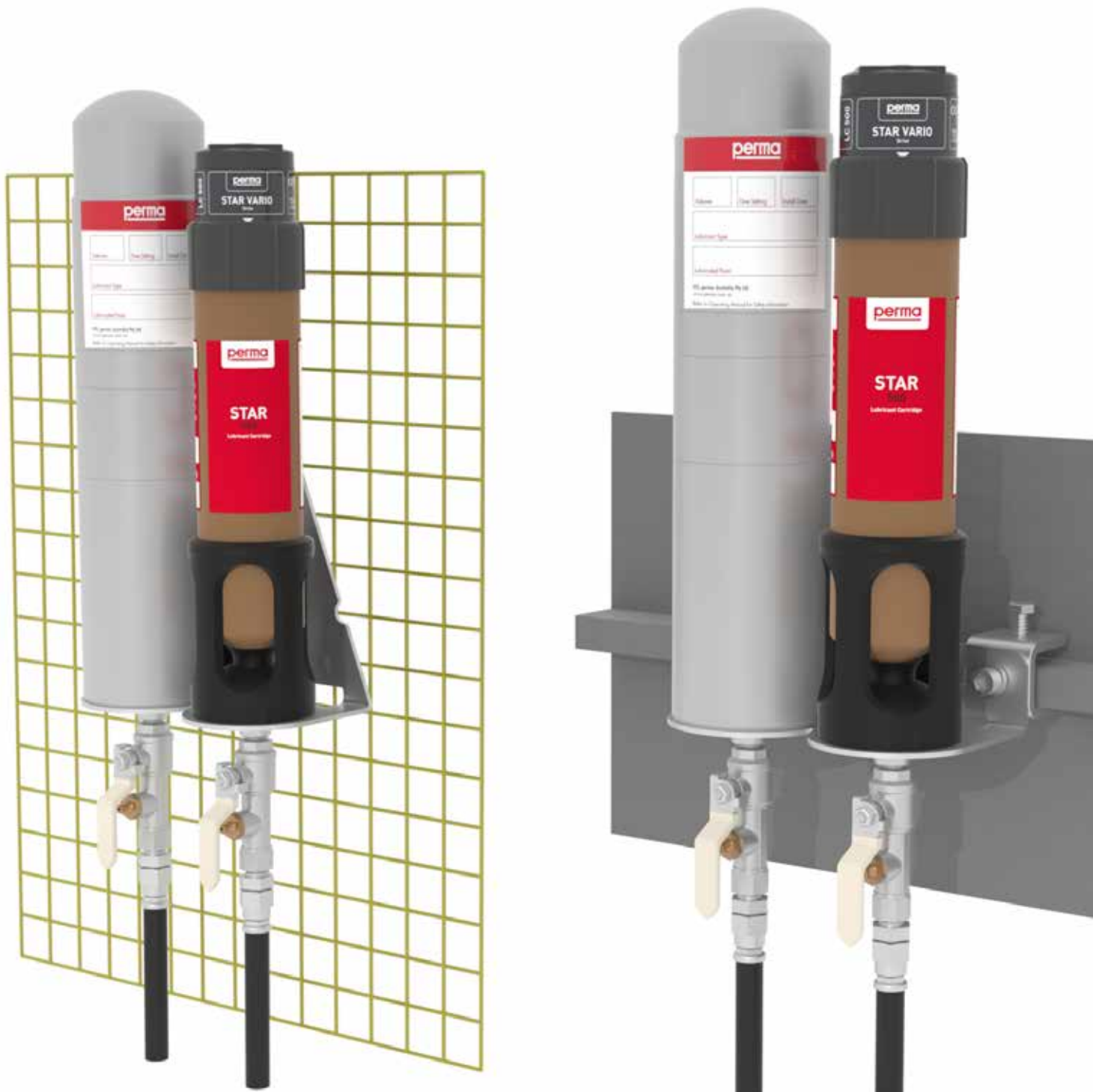

Standard Duty installation kits are highly versatile and can be adapted for attachment to beam sections or square mesh safety cages. The brackets included in Standard Duty kits are fabricated in Australia from stainless steel.

Standard Duty kits include lubricator covers and manual purge kits for each lubrication point along with a range of commonly required fittings, push-lock swivel hose ends and high quality Ryco brand hose with 3/8" internal diameter.

* All perma STAR VARIO installation kits are compatible with perma STAR VARIO BLUETOOTH® and perma STAR CONTROL lubricators.

Standard Duty Beam

The range of Standard Duty kits with beam clamps includes options for 1, 2, 3 or 4 points. Beam clamp options include 30mm and 65mm sizes, as indicated by the 3rd and 4th digits of the product part number – **30** for 30mm clamps and **65** for 65mm clamps.



K130X (with 30mm beam clamps)
K165X (with 65mm beam clamps)



K230X (with 30mm beam clamps)
K265X (with 65mm beam clamps)



K330X (with 30mm beam clamps)
K365X (with 65mm beam clamps)



K430X (with 30mm beam clamps)
K465X (with 65mm beam clamps)

Example installation kit contents – K230X

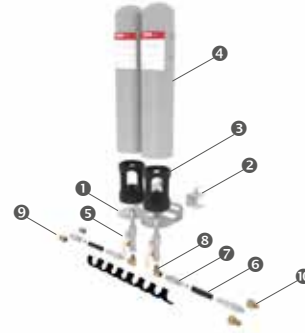

Bill of Materials

1	1 x 2 point standard duty bracket	6	4m of 3/8" ID grease line
2	2 x 30mm S/S beam clamps	7	4 x female swivel hose ends
3	2 x lubricator support flanges	8	2 x 90 degree elbows
4	2 x full length covers	9	2 x 1/4" BSPF-1/8" BSPM reducers
5	2 x manual purge kits	10	2 x 1/4" BSPF -1/4" BSPM extension

Standard Duty Cage Mount

The range of Standard Duty installation kits with cage hooks are suited to square cage down to a mesh size of 25 x 25mm. Installation kits are available for 1, 2, 3 or 4 points as summarised below. **CH** as the 3rd and 4th digits of the product part number indicates the inclusion of cage hook.



K1CHX



K2CHX



K3CHX



K4CHX

Example installation kit contents – K2CHX



Bill of Materials

1	1 x 2 point standard duty cage bracket	6	4 x Female swivel hose ends
2	2 x Lubricator support flanges	7	2 x 90 degree elbows
3	2 x full length covers	8	2 x 1/4" BSPF-1/8" BSPM reducers
4	2 x Manual purge kits	9	2 x 1/4" BSPF -1/4" BSPM extension
5	4m of 3/8" ID grease line		

Installation Kits*

Heavy Duty - 500cm³



Heavy Duty installation kits have been specifically designed for use in operational areas which are subject to regular wash down and water impact, such as the conditions found in coal handling preparation plants. The installation kits are highly versatile and can be adapted for attachment to beam sections and square mesh safety cages. The bracket systems included in Heavy Duty installation kits are fabricated in Australia from stainless steel.

Heavy Duty installation kits include lubricator covers and manual purge kits for each lubrication point along with a range of commonly required fittings, push-lock swivel hose ends and high quality Ryco brand hose with 3/8" internal diameter.

* All perma STAR VARIO installation kits are compatible with perma STAR VARIO BLUETOOTH® and perma STAR CONTROL lubricators.

Heavy Duty Beam

The range of Heavy Duty kits with beam clamps includes options for 1, 2, 3 or 4 points. Beam clamp options include 30mm and 65mm sizes, as indicated by the 3rd and 4th digits of the product part number – **30** for 30mm clamps and **65** for 65mm clamps.



K130CX (with 30mm beam clamps)
K165CX (with 65mm beam clamps)



K230CX (with 30mm beam clamps)
K265CX (with 65mm beam clamps)



K330CX (with 30mm beam clamps)
K365CX (with 65mm beam clamps)



K430CX (with 30mm beam clamps)
K465CX (with 65mm beam clamps)

Example Installation Kit Contents – K230CX

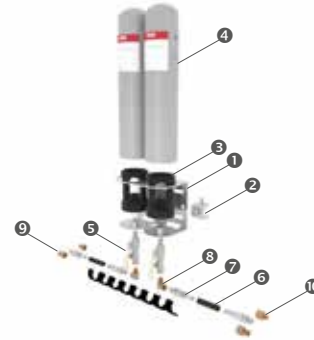

Bill of Materials

1	1 x 2 point heavy duty bracket	6	4m of 3/8" ID grease line
2	2 x 30mm S/S beam clamps	7	4 x female swivel hose ends
3	2 x lubricator support flanges	8	2 x 90 degree elbows
4	2 x full length covers	9	2 x 1/4" BSPF-1/8" BSPM reducers
5	2 x manual purge kits	10	2 x 1/4" BSPF -1/4" BSPM extension

Heavy Duty Cage Mount

The range of Heavy Duty installation kits with cage hooks are suited to square cage down to a mesh size of 25 x 25mm. Installation kits are available for 1, 2, 3 or 4 points as summarised below. **CH** as the 3rd and 4th digits of the product part number indicates the inclusion of cage hook.



K1CHCX



K2CHCX



K3CHCX



K4CHCX

Example Installation Kit Contents – K2CHCX

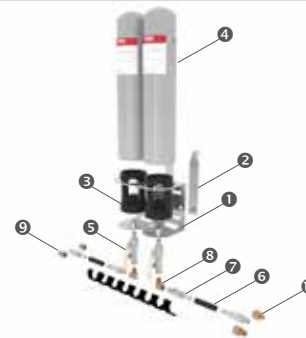

Bill of Materials

1	1 x 2 point heavy duty bracket	6	4m of 3/8" ID grease line
2	1 x cage hook arm set	7	4 x female swivel hose ends
3	2 x lubricator support flanges	8	2 x 90 degree elbows
4	2 x full length covers	9	2 x 1/4" BSPF-1/8" BSPM reducers
5	2 x manual purge kits	10	2 x 1/4" BSPF -1/4" BSPM extension

Remote Installations

General guidelines

Year by year, improvements to safe work practices and increased production demands lead to an increasing requirement to remote mount automatic lubricators so that they can be accessed while equipment is operating. Correct remote mounting practices require that simple, yet important guidelines be followed:

- Locate lubricators where they can be safely and easily accessed while equipment is operating
- Select stainless steel brackets which can be easily removed if required for maintenance access
- Include manual purge points to provide an efficient means of occasional manual purging
- Use only full bore elbow fittings
- Use 3/8" internal diameter grease line and run lines under or around cages

Remote installation decision making

For many lubrication points it is beneficial to mount lubricators where they are safe to access while machinery is operating. The questions in the table below can be used to help guide remote mounting decisions. An answer of “yes” to any of the questions indicates that remote mounting is likely to be required.

Question	Answer
1. Is it necessary to remove protective guards or safety cages to access the lubrication point?	Yes – remote mount No – direct mount
2. Is it difficult or unsafe to access the lubrication point while equipment is running?	Yes – remote mount No – direct mount
3. Is the lubrication point subject to severe vibration or high temperatures which may damage the lubricator?	Yes – remote mount No – direct mount
4. Is it necessary to get permits to access lubrication points such as those in confined spaces or located at heights?	Yes – remote mount No – direct mount
5. Is the lubrication point exposed to excessive amounts of water, process materials or impact from solid material?	Yes – remote mount No – direct mount



- Select grease line with **3/8" internal diameter**
- Restrict the maximum grease line to a length of **5 meters****
- Select full bore hose end fittings and elbows
- Select stainless steel bracket and locate at a safe point of access
- Route grease lines under or around cage mesh, not through
- Prime grease lines and fittings
- Test the grease delivery path to the lubrication point after priming to ensure that back pressure is not excessive

** This is a guide. Limits depend on variables such as line ID, grease type, temperature and the resistance of the lubrication point itself. Contact your perma supplier for further information.

General guidelines for remote installations

Remote installation kits are designed to be simple to install. The minimum tools required to complete a typical installation include: 2 x shifters, 5/16" Allen key, hose cutters and grease gun.

The following installation tips should be followed:

1. Use a grease gun to test that lubrication points can receive grease freely. Use this opportunity to pre-grease the points if practical to do so. Do not use a powered grease gun because it will not be possible to detect high flow resistance.
2. Identify a bracket mounting position which is safe to access for lubricator servicing:
 - Ensure that there is space above the lubricators for covers to be removed.
 - Avoid interference with inspection hatches, frequently removed guards and emergency stop cords.
3. Plan grease line routes carefully:
 - Run grease lines under, over or around cages. Not through.
 - Secure and protect grease lines using cable ties and spiral wrap.
4. Apply grease to hose end barbs for easy fitting. Cold hose may need to be warmed. Push the hose on using two hands with a firm downwards motion.
5. Fill grease lines with fresh grease.
6. Where the threat of corrosion is high, use Denso wrap to protect hose ends.
7. Use a thread locking and sealing product to ensure that fittings are secure and to prevent oil weep.

Common Equipment & Applications

Slurry pumps



Slurry pumps used in operations such as coal preparation plants must endure harsh conditions. Efforts to prevent the entry of water and solid contaminants to pump barrels will extend bearing service lives.

The use of automatic lubrication systems to provide a regular purge of fresh grease through the labyrinth seals of pump barrels is a common and proven method of preventing contaminant entry. As the harshness of the operating conditions increases, so too does the importance of the automatic purging.

Pumps which are subjected to regular wash down or which have water impingement to the wet-end labyrinth demand higher labyrinth purge rates.

In addition to seal purging, automatic systems can also be implemented for bearing relubrication in order to provide precise and controlled grease delivery, thereby avoiding grease starvation and over lubrication.

Lubrication assessment criteria

For slurry pump lubrication the following factors are generally assessed in order to develop the lubrication solution:

- Pump manufacturer's recommendations
- Seal types
- Bearing types, grease entry points and grease migration directions
- Characteristics of proposed lubricant
- Typical bearing operating temperatures
- Duty cycle
- Historical lubrication practices
- Desired service schedule
- Operating conditions
- Wash down procedures
- Requirements for safe access

Installation examples



Application Labyrinth seals and mechanical seal
Lubricator perma STAR VARIO 250cm³
Installation kit K230C & direct mount



Application Labyrinth seals and gland seal
Lubricator perma STAR VARIO 250cm³
Installation kit K365C



Application Sump pump
Lubricator perma STAR VARIO 250cm³
Installation kit K230C



Application Labyrinth seals
Lubricator perma STAR VARIO 500cm³
Installation kit K265CX

Common Equipment & Applications

Conveyor pulley bearings

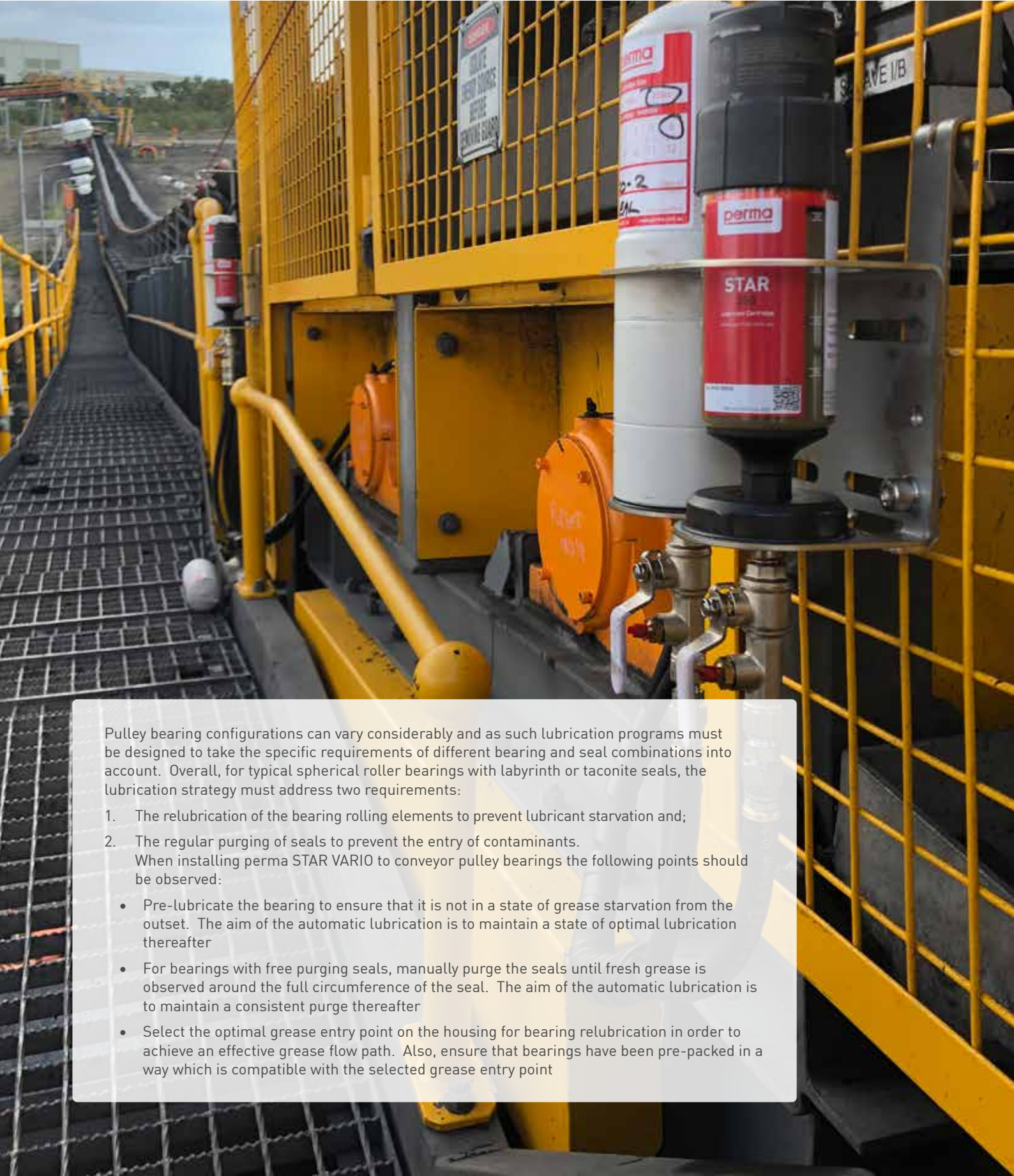

Pulley bearing configurations can vary considerably and as such lubrication programs must be designed to take the specific requirements of different bearing and seal combinations into account. Overall, for typical spherical roller bearings with labyrinth or taconite seals, the lubrication strategy must address two requirements:

1. The relubrication of the bearing rolling elements to prevent lubricant starvation and;
 2. The regular purging of seals to prevent the entry of contaminants.
- When installing perma STAR VARIO to conveyor pulley bearings the following points should be observed:
- Pre-lubricate the bearing to ensure that it is not in a state of grease starvation from the outset. The aim of the automatic lubrication is to maintain a state of optimal lubrication thereafter
 - For bearings with free purging seals, manually purge the seals until fresh grease is observed around the full circumference of the seal. The aim of the automatic lubrication is to maintain a consistent purge thereafter
 - Select the optimal grease entry point on the housing for bearing relubrication in order to achieve an effective grease flow path. Also, ensure that bearings have been pre-packed in a way which is compatible with the selected grease entry point

Lubrication assessment criteria

For conveyor pulley bearing lubrication the following factors are generally assessed in order to develop the lubrication solution:

- Bearing types & speeds
- Seal types
- Location of grease entry points on bearing housings
- Characteristics of proposed lubricant
- Operating conditions
- Historical lubrication practices
- Requirements for safe access
- Desired service schedule

Installation examples



Application Conveyor pulley bearing and seal
Lubricator perma STAR VARIO 250cm³
Installation kit K230C



Application Conveyor pulley bearing and seal
Lubricator perma STAR VARIO 250cm³
Installation kit K330



Application Conveyor pulley bearing and seal
Lubricator perma STAR VARIO 250cm³
Installation kit K2CH



Application Conveyor pulley bearings and seals
Lubricator perma STAR VARIO 500cm³
Installation kit K3CHCX

Common Equipment & Applications

Electric Motors



Electric motor bearing relubrication is a critical aspect of maintenance. As with other high speed bearing applications, it is important for relubrication practices to take the risks associated with over-lubrication into account while providing sufficient relubrication to deliver long bearing service life.

The combination of the following practices can provide a lubrication program which avoids over-lubrication and lubricant starvation:

- Add small amounts of grease at short time intervals using an automatic lubricator which provides accurate dispensing rates, independent of temperature
- Re-lubricate when the motor is in operation
- Always ensure that spent grease can escape the bearing housing via well maintained grease escape holes or collection traps
- Do not use powered grease guns

Lubrication assessment criteria

For electric motor lubrication the following factors are generally assessed in order to develop the lubrication solution:

- Motor manufacturer's recommendations
- Motor speed
- Grease trap / escape port design, access and condition
- Bearing types
- Characteristics of proposed lubricant
- Historical lubrication practices
- Duty cycle
- Motor orientation (vertical or horizontal)

Installation examples



Application Electric motor
Lubricator perma STAR VARIO 250cm³
Installation kit K230C



Application Electric motor
Lubricator perma STAR VARIO 120cm³
Installation kit Direct mount



Application Electric motor
Lubricator perma STAR VARIO 250cm³
Installation kit K230C



Application Electric motor
Lubricator perma STAR VARIO 250cm³
Installation kit Direct mount

Common Equipment & Applications

Fans



Fan support bearings require particular attention when devising a lubrication strategy. Because a broad range of bearing types can be employed it is important to understand the bearing and seal types before proceeding. This information is critical in order to understand the optimal grease delivery points, grease flow paths, the requirements for efficient grease exchange and the point(s) of grease exit from bearing housings.

During the implementation of perma STAR VARIO it is important to address the following items:

- Ensure that the bearing housing is correctly packed with grease in order to ensure efficient grease exchange. This is especially important for bearing types which must be re-lubricated from the side, rather than via a central relubrication groove
- Where contact seals which are not free purging are in use, such as double lip seals, ensure that a suitable point for grease relief is introduced to the housing in order to avoid over-lubrication
- Consider the use of high performance greases which can withstand the high rate of mechanical work which is applied by high speed rolling element bearings such as spherical roller bearings

Lubrication assessment criteria

For fan lubrication the following factors are generally assessed in order to develop the lubrication solution:

- Bearing types & speeds
- Seal types
- Grease entry points and grease migration directions
- Typical bearing operating temperatures
- Characteristics of proposed lubricant
- Historical lubrication practices
- Operating conditions
- Requirements for safe access
- Desired service schedule

Installation examples



Application Fan support bearings
Lubricator perma STAR VARIO 250cm³
Installation kit K230



Application Fan support bearings
Lubricator perma STAR VARIO 120cm³
Installation kit Direct mount



Application Fan support bearings
Lubricator perma STAR VARIO 250cm³
Installation kit K230



Application Fan support bearings
Lubricator perma STAR VARIO 250cm³
Installation kit K330

Accessories

The correct accessories for your mounting solution

A close-up photograph of industrial hydraulic hoses. The hoses are black with brass fittings. One hose is connected to a metal manifold with a brass elbow fitting. Another hose is connected to a similar fitting. The background is a dark, textured metal surface, possibly part of a machine or engine. The lighting is bright, highlighting the metallic surfaces and the texture of the hoses.

Minimising the pressure loss between single point lubricators and lubrication points is an important factor for achieving long term, reliable lubricant delivery. The range of accessories available from perma have been carefully selected to ensure that pressure losses are minimised and that installations will stand the test of time in harsh operating environments.

Adaptors, elbows, extensions, grease lines & general fittings

perma STAR VARIO lubricators have a 1/4" BSP male thread at the grease outlet. Where reducers, elbows or extension are required to facilitate installation it is important to adhere to the following guidelines:

- When using reducing adaptors down to fine threads such as 6mm metric or 1/4" UNF select stainless steel to avoid breakage
- Minimise the number of elbow fittings
- Always select full bore elbows



Part #	Description	Pic.	Part #	Description	Pic.
2461/8	Straight adaptor brass 1/4" BSPP F - 1/8" BSPT M	1	92JSS	Elbow stainless steel 90 degree 1/4" BSPT M - 9/16" JIC M	-
2461/4	Straight adaptor brass 1/4" BSPP F - 1/8" BSPT M	2	921/8JSS	Elbow stainless steel 90 degree 1/8" BSPT M - 9/16" JIC M	-
2461/4UNFSS	Straight adaptor stainless steel 1/4" BSPP F - 1/4" UNF M	3	92	Elbow brass 90 degree 1/4" BSPP F - 1/4" BSPT M	11
2466SS	Straight adaptor stainless steel 1/4" BSPP F - M6x1.0 M	4	1216SS	Elbow brass 45 degree 1/4" BSPP F - M6x1.0 M	-
2468	Straight adaptor brass 1/4" BSPP F - M8x1.0 M	5	1211/8	Elbow brass 45 degree 1/4" BSPP F - 1/8" BSPT M	-
2468SS	Straight adaptor stainless steel 1/4" BSPP F - M8x1.0M	6	1211/4	Elbow brass 45 degree 1/4" BSPP F - 1/4" BSPT M	12
24610	Straight adaptor brass 1/4" BSPP F - M10x1.0 M	7	52740	Extension brass 40mm 1/4" BSPP F - 1/4" BSPT M	-
24610SS	Straight adaptor stainless steel 1/4" BSPP F - M10x1.0M	8	5270501/8	Extension brass 50mm 1/4" BSPP F - 1/8" BSPT M	-
88HDJ	Hose end swivel 3/8" hose to 1/4" BSP M	9	52750M6SS	Extension stainless steel 50mm 1/4" BSPP F - M6x1.0 M	13
90HD	Hose baryon fibre reinforced internal diameter 3/8"	-	52785	Extension brass 85mm 1/4" BSPP F - 1/4" BSPT M	-
708V	Manual greasing kit 1/4" BSP	14	527125	Extension brass 125mm 1/4" BSPP F - 1/4" BSPT M	-
HDC250	Full length cover heavy duty for L250 STAR VARIO	10	A620P	Support flange 1/4" BSP	15



Stainless steel brackets and attachment options

The range of stainless steel brackets and attachment options included in remote installation kits can be purchased as separate components. Brackets are available bare or complete with A620P support flanges. The A620P reinforces perma STAR VARIO lubricators to protect against accidental breakage. The table below includes bare brackets and brackets with A620P's. Note that Heavy Duty C-Section brackets always include A620P's and full length covers. With the exception of Heavy Duty brackets, only bare brackets are pictured below.

Part # (bare)	Description	Pic.	Part # (with A620P)	Compatible attachment options
BC30	Beam clamp 30mm	A	-	This is an attachment option
BC65	Beam clamp 65mm	B	-	This is an attachment option
CH-ARMS	Cage hanger twin arm set	C	-	This is an attachment option
MB01	Standard duty 1 point bracket	1	MB01A620P	Select from BC30 or BC65
MB02	Standard duty 2 points bracket	2	MB02A620P	Select from BC30 or BC65
MB03	Standard duty 3 points bracket	3	MB03A620P	Select from BC30 or BC65
MB04	Standard duty 4 points bracket	4	MB04A620P	Select from BC30 or BC65
-	Heavy duty C-section 1 point bracket	5	MB01C	Select from BC30 or BC65 or CH-ARMS
-	Heavy duty C-section 2 points bracket	6	MB02C	Select from BC30 or BC65 or CH-ARMS
-	Heavy duty C-section 3 points bracket	7	MB03C	Select from BC30 or BC65 or CH-ARMS
-	Heavy duty C-section 4 points bracket	8	MB04C	Select from BC30 or BC65 or CH-ARMS
CH01	Cage hanger 1 point bracket	9	CH01A620P	Cage hooks supplied with bracket
CH02	Cage hanger 2 points bracket	10	CH02A620P	Cage hooks supplied with bracket
CH03	Cage hanger 3 points bracket	11	CH03A620P	Cage hooks supplied with bracket
CH04	Cage hanger 4 points bracket	12	CH04A620P	Cage hooks supplied with bracket
MB01R	Rail mount 1 point bracket	13	MB01RA620P	U-bolts supplied with bracket
MB02R	Rail mount 2 points bracket	14	MB02RA620P	U-bolts supplied with bracket
MB03R	Rail mount 3 points bracket	15	MB03RA620P	U-bolts supplied with bracket
MB04R	Rail mount 4 points bracket	16	MB04RA620P	U-bolts supplied with bracket

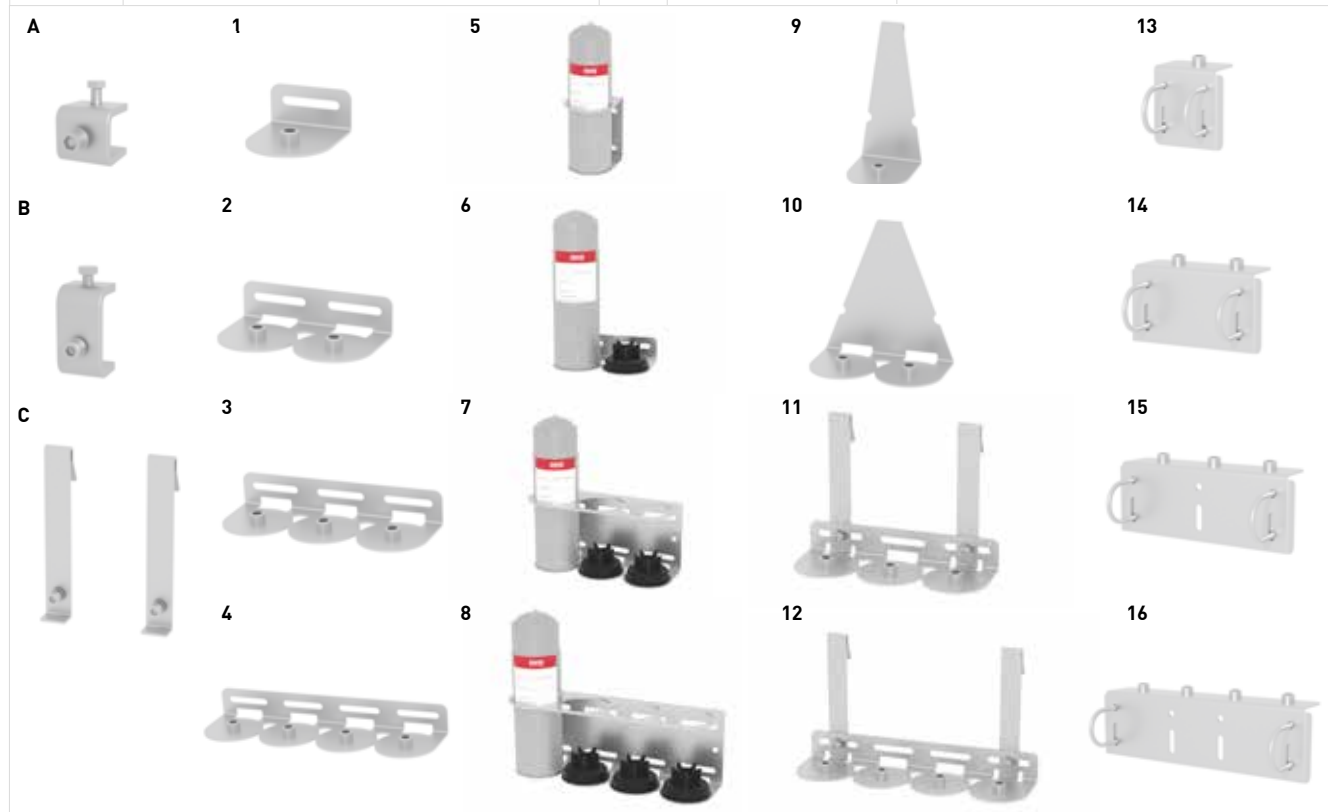

Pre-assembled and pre-filled lubricator grease lines

Pre-assembled, pre-filled grease lines are supplied ready to use. They save time, ensure against the accidental inclusion of contaminants when making grease lines on site and remove the need for laborious manual filling. The range of grease lines from perma come in pre-set lengths.

- 3/8" internal diameter with single, synthetic fibre braid.
- Full bore female swivel, push-lock fittings at each end of hose for convenient fitting with adaptors to 1/4" BSP male
- Minimum burst pressure = 84 bar
- Complies with FRAS AS2660
- Minimum bend radius 76mm

Line Length	0.5m	0.75m	1.0m	1.5m	2.0m	2.5m	3.0m
Generic Part #	PSFXXX90HD0.5	PSFXXX90HD.75	PSFXXX90HD1.0	PSFXXX90HD1.5	PSFXXX90HD2.0	PSFXXX90HD2.5	PSFXXX90HD3.0

The table above provides generic part numbers for different length hose assemblies. The first 6 digits of each part number identifies the grease type. Specific part numbers for preferred grease types are created by replacing the first six digits of the generic part number with the relevant perma lubricant code.

For example, a pre-assembled grease line with a length of 1.5 meters which is filled with Castrol Spheerol LX EP2 grease:

- Generic part number for 1.5 meter line is PSFXXX90HD1.5
- 6 digit reference code for Castrol Spheerol LX EP2 grease is PSF826
- Hence, part number for required line is PSF82690HD1.5

Chain lubrication accessories

Part #	Description	Pic.	Part #	Description	Pic.
A400	Brush 20cm round 1/4 " BSP for oil	1	A810	Throttle one-way valve 1/4 " BSP for oil	5
A410*	Brush 3 x 4cm rectangular 1/4 " BSP for oil	2	A100	Metal bracket standard duty	6
A411*	Brush 3 x 6cm rectangular 1/4 " BSP for oil	3	A105	Universal plastic bracket	7
A412*	Brush 3 x 10cm rectangular 1/4 " BSP for oil	4	A150	T-piece bracket with 1/4 " BSP insert	8



Fittings Cases

Part numbers and case contents



Various fittings cases are available to provide a convenient and economical option for on-site spares. The themed cases include carefully selected reducing adaptors, extensions and elbows. The cases have a heavy duty plastic construction with an integrated water seal, removable compartments, impact resistant lid and heavy duty latches. The tables opposite list the parts included in each fittings case option. If different combinations are required please contact your supply of perma products to investigate the supply of a customised option.

FCGEN220 - Includes the most commonly used fittings for STAR VARIO users

Part #	Count	Description
A620P	20	Support flange suits STAR 1/4" BSPT M
708V	10	Manual greasing kit 1/4" BSP
88HDJ	20	Hose end swivel 3/8" hose to 1/4" BSP M
92	20	Elbow brass 90 degree 1/4" BSPP F - 1/4" BSPT M
1211/4	20	Elbow brass 45 degree 1/4" BSPP F - 1/4" BSPT M
2461/8	30	Straight adaptor brass 1/4" BSPP F - 1/8" BSPT M
527501/8	20	Extension brass 50mm 1/4" BSPP F - 1/8" BSPT M
52750M6SS	20	Extension stainless steel 50mm 1/4" BSPP F - M6x1.0 M
2466SS	30	Straight adaptor stainless steel 1/4" BSPP F - M6x1.0 M
2461/4UNFSS-C	30	Straight adaptor stainless steel 1/4" BSPP F - 1/4" UNF M

FCBSP240 - Primarily brass BSP fittings plus stainless reducers to M6X1.0 and 1/4" UNF

Part #	Count	Description
2461/4	30	Straight adaptor brass 1/4" BSPP F - 1/4" BSPT M
2461/8	30	Straight adaptor brass 1/4" BSPP F - 1/8" BSPT M
92	40	Elbow brass 90 degree 1/4" BSPP F - 1/4" BSPT M
1211/4	40	Elbow brass 45 degree 1/4" BSPP F - 1/4" BSPT M
1211/8	20	Elbow brass 45 degree 1/4" BSPP F - 1/8" BSPT M
527501/8	15	Extension brass 50mm 1/4" BSPP F - 1/8" BSPT M
52740	15	Extension brass 40mm 1/4" BSPP F - 1/4" BSPT M
52750M6SS	10	Extension stainless steel 50mm 1/4" BSPP F - M6x1.0 M
2466SS	20	Straight adaptor stainless steel 1/4" BSPP F - M6x1.0 M
2461/4UNFSS	20	Straight adaptor stainless steel 1/4" BSPP F - 1/4" UNF M

FCMETRIC230 - Primarily adaptors from metric to 1/4" BSPP F plus BSP elbows and reducers

Part #	Count	Description
2466SS	30	Straight adaptor stainless steel 1/4" BSPP F - M6x1.0 M
1216SS	20	Elbow brass 45 degree 1/4" BSPP F - M6x1.0 M
52750M6SS	15	Extension stainless steel 50mm 1/4" BSPP F - M6x1.0 M
2468	25	Straight adaptor brass 1/4" BSPP F - M8x1.0 M
2468X1.25	20	Straight adaptor brass 1/4" BSPP F - M8x1.25 M
24610	20	Straight adaptor brass 1/4" BSPP F - M10x1.0 M
246810X1.25	20	Straight adaptor brass 1/4" BSPP F - M10x1.25 M
246810X1.5	20	Straight adaptor brass 1/4" BSPP F - M10x1.5 M
52740	20	Extension brass 40mm 1/4" BSPP F - 1/4" BSPT M
92	40	Elbow brass 90 degree 1/4" BSPP F - 1/4" BSPT M

FCSS250 - Includes a range of stainless steel fittings

Part #	Count	Description
2466SS	20	Straight adaptor stainless steel 1/4" BSPP F - M6x1.0 M
1216SS	20	Elbow stainless steel 45 degree 1/4" BSPP F - M6x1.0 M
52750M6SS	10	Extension stainless steel 50mm 1/4" BSPP F - M6x1.0 M
2468SS	20	Straight adaptor stainless steel 1/4" BSPP F - M8x1.0 M
24610SS	20	Straight adaptor stainless steel 1/4" BSPP F - M10x1.0 M
2461/4UNFSS	30	Straight adaptor stainless steel 1/4" BSPP F - 1/4" UNF M
2461/8SS	20	Straight adaptor stainless steel 1/4" BSPP F - 1/8" BSPT M
48SS	30	Grease nipple stainless steel 1/4" BSPT M
280SS	40	Nipple 1/4" BSPT M - 1/4" BSPT M
26SS	40	Socket round 1/4" BSP

Inspection Guidelines

The periodic inspection of lubricators is important to support the integrity of the overall lubrication program

The following points are important:

- Inspection of lubricators should be carried out by a competent person who understands the various display and light sequence combinations
- A permanent marker should be carried in order to mark and date the piston positions

A Remove lubricator cover. Leave the lubricator in its mounted position to complete the inspection.



B Confirm status using the display screen / flashing lights. The time setting on the display and a green light indicates normal operation.



C Check, mark and date the position of the piston. Compare the position to the expected piston position.



D Refit lubricator cover.



E Check the condition of fittings and grease lines. Repair or raise work orders as required.



Service Guidelines

The service procedure for the perma STAR VARIO is summarised here

Important notes to include:

- ALWAYS exchange battery set
- ALWAYS record service dates on canister
- Lubricators can be serviced without removing the clear wet cap
- Replacing the battery set automatically resets the lubricator so there is no need to turn lubricators OFF and then ON again when servicing

A

Confirm lubricator status via display screen & piston level.



B

Do not turn the lubricator off. Remove lubricator, disassemble & remove battery set using eject trigger.



C

Exchange lubricant canister and battery set.



D

Insert new battery set, attach new canister and re-assemble. An automatic self test will occur.



E

Lubricator will start automatically. Observe first run cycle and afterwards confirm that the setting is correct



F

Record installation and next service dates on canister and remount to lubrication point.



perma LUBRICANTS

The correct lubricant for a longer service life



The frequent addition of small volumes of lubricant provides the longest bearing service life and therefore reduces maintenance costs. Lubricant selection is also an important factor for achieving extended bearing service life.

To fulfill this requirement perma lubricators are filled standard with a range of high quality German manufactured lubricants.

HTL perma Australia also has the capability to custom fill greases and oils. This ensures that users of perma lubricators are not forced to make compromises when it comes to choice of lubricant.

Custom fill lubricants

HTL perma Australia Pty Ltd is equipped with lubricator filling machines from Germany and has the capability to custom fill lubricators with any suitable grease or oil.

The demand for custom filled lubricants is increasing. Typical reasons for choosing custom filled lubricants are:

- Where lubricant rationalisation programs have been implemented and it is preferred that the lubricants in automatic lubricators conform to the rationalisation decisions
- Where certain applications demand specialty lubricants
- Where the mixing of different lubricants presents a real risk of incompatibility problems
- Where specific lubricants are required in order to satisfy warranty requirements
- Where specific lubricant brands must be used in order to adhere to contractual obligations

→ perma code → Description	NLGI class	Thickener	Base oil	Operating temperature (°C)	Viscosity at +40°C	Roller bearings	Sliding bearings Guides	Linear guides	Open gears Gear racks	Spindles	Shaft seals (1)	Chains
GREASE												
SF01 Multipurpose grease	2	Li / Ca	Mineral oil	-30 to +130	220	✓	✓	✓	-	✓	✓	-
PSF721 Multipurpose blue grease	2	Li / Ca	Mineral oil	-30 to +130	220	✓	✓	✓	-	✓	✓	-
SF02 Extreme pressure grease	2	Li + MoS2	Mineral oil	-30 to +120	105	-	✓	-	✓	-	-	-
SF10 Food grade grease	1	Al-Com,	PAO	-45 to +120	150	✓	✓	✓	✓	-	-	-
OIL												
S014 High temperature chain oil	Oil	-	PAO + Ester	-20 to +250	320	-	-	-	-	-	-	✓
S032 Multipurpose oil	Oil	-	Mineral oil	-5 to +100	100	-	✓	-	✓	✓	-	✓
S070 Food grade oil	Oil	-	PAO + Ester	-30 to +120	220	-	✓	-	✓	✓	-	✓

Grease pumpability

The pumpability of grease depends on a range of factors, the most influential being the thickener type and NLGI number, temperature and the internal dimensions of delivery lines and fittings.

Grease type - The lower the NLGI rating the easier grease is to pump. NLGI 2 greases are easier to pump than NLGI 3 greases and so on. Grease thickener type, base fluid viscosity and manufacturing methods also have an effect on grease pumpability.

Temperature - Grease is easier to pump in warmer environments than in cold environments. However, the relationship between pumpability and temperature is not linear, so as temperature drops it is difficult to predict the point at which grease will become substantially more difficult to pump.

Grease line dimensions and fittings - The nature of grease flow through lines and fittings is different to that of liquid lubricants such that pressure drops cannot be calculated on the basis of "pipe friction loss" style calculations. In general it is best to minimise grease line length, use generous sized grease line (perma recommends 3/8" ID) and eliminate restrictive elbow fittings.



HTL perma Australia Pty Ltd

150 Highbury Road
Burwood, VIC 3125
AUSTRALIA

+61 3 9273 7700
technical@perma.com.au
www.perma.com.au